

Anycubic Photon Workshop

Usage Instructions

Copyrighted by "Shenzhen Anycubic Technology Co., Ltd ", all rights reserved.

Team **ANYCUBIC**

Contents

01 Installation & Update	3
02 Overview	7
03 Settings	8
1. Import	8
2. Machine Configuration Manage	10
3. Anycubic Cloud	16
04 Introduction to Functions	17
1. View Changing	17
2. Model Edit	18
3. Clone	19
4. Repair	20
5. Hollow	21
6. Punch	22
7. Free Cut	23
8. Text	24
9. Face Model	26
05 Support Settings	28
1. Basic Settings	28
2. Support Scripts Settings	31
3. Automatic Support Adding Skills	36
4. Save Scene File	37
06 Export Sliced File	38

Installation & Update

Anycubic Photon Workshop installation package is located in memory stick, please install and update the software as following steps. Do not run the older versions of Anycubic Photon Workshop in case of installation failure.

1. Installation

• Windows

Close the anti-virus software before installation. Open the suitable package and then follow the guide as shown below.



• Mac

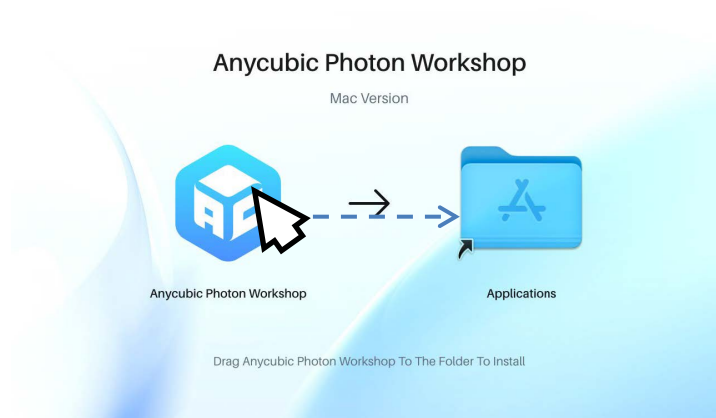

Double click the installer and then drag Anycubic Photon Workshop to the applications as shown above

Installation & Update

Anycubic Photon Workshop V3.X.X System Requirements

Windows

CPU	Intel® Core™ i5 6600K or higher AMD Ryzen™ 5 1600 or higher
RAM	≥ 16 GB
Free Disk Space	2 GB
Display Resolution	≥ 1920*1080 ≥ 2560*1440 (suggested)
GPU	NVIDIA GeForce GTX1050 or higher AMD Radeon RX480 or higher
GPU RAM	≥ 1GB

Mac OS

CPU	Intel® 4-Core (OS version 10.15) or higher Apple M1 4-Core (OS version 13.0) or higher
RAM	≥ 16 GB
Disk Space	≥ 64 GB
Display Resolution	≥ 2560*1440

Installation & Update

2. Language

Click “偏好” - “偏好设置” - “语言” to switch the language to English if the language is set as Chinese.



Installation & Update

3. Update

If a new version is released, it will be a popup asking you to update when you open the software. You can also click Help - Check Update to check whether the software update to the latest version. If the automatic update is unnecessary, cancel the selection of “Automatically check for updates”.



Notice: Anycubic Photon Workshop and its instructions may be updated irregularly. Please visit www.anycubic.com for the latest updates.

Overview

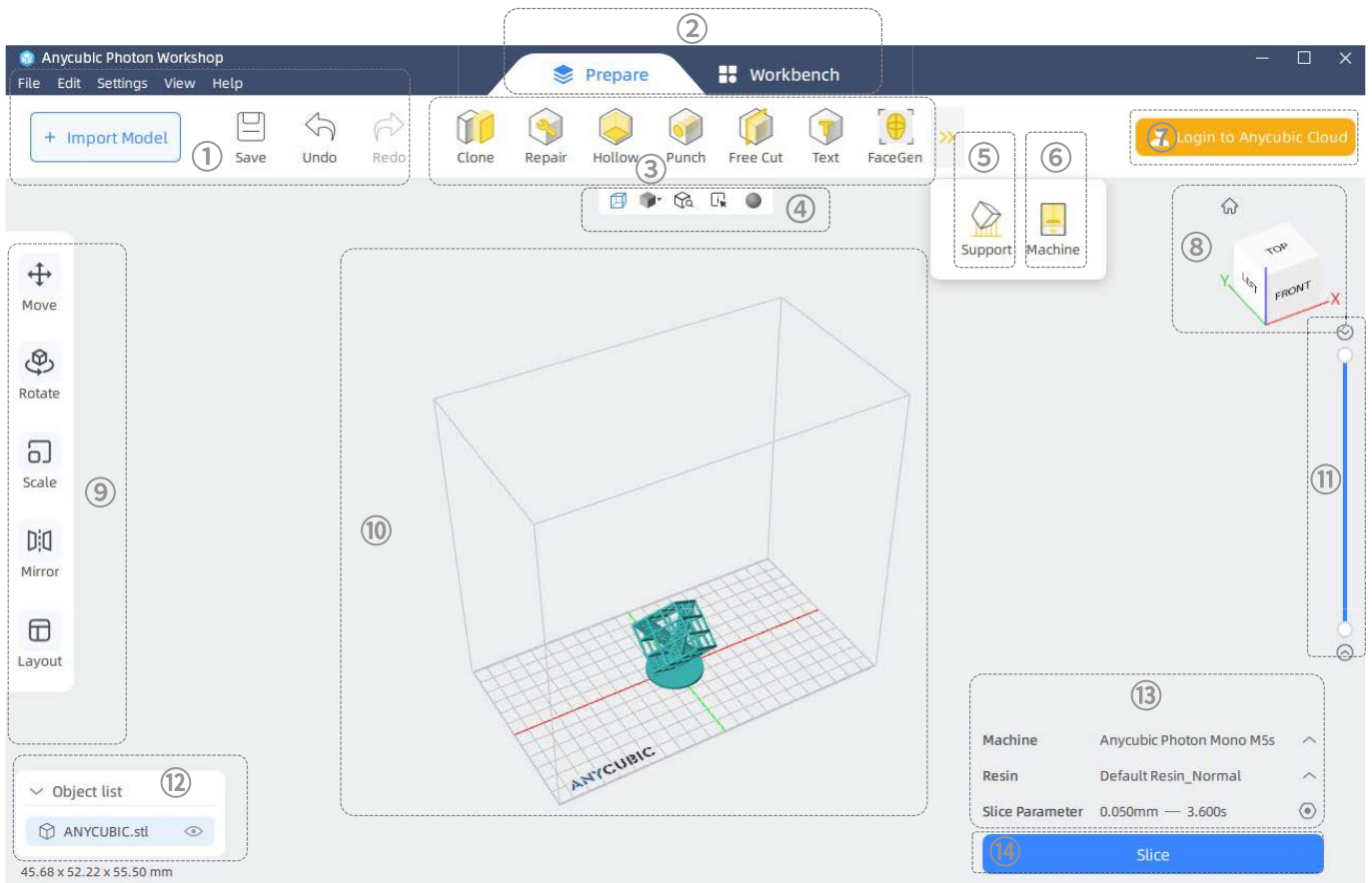

- ① Open/save file, undo/redo
- ② Switch to Prepare/Workbench interface
- ③ Functions to edit the slice file
- ④ View mode
- ⑤ Support settings
- ⑥ Machine settings
- ⑦ Login to Anycubic Cloud
- ⑧ View switcher
- ⑨ To edit the objects
- ⑩ 3D model preview
- ⑪ Drag the slider to preview each layer of the model
- ⑫ Object list
- ⑬ Configuration of machine, resin and slice parameters
- ⑭ Slice button

Settings

1. Import

Import your own 3D model(STL, OBJ, etc.), or scene.

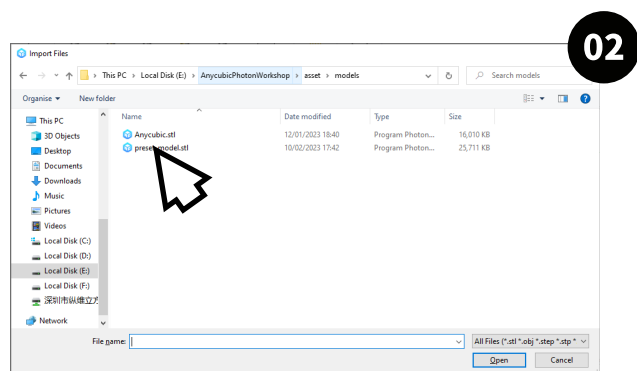
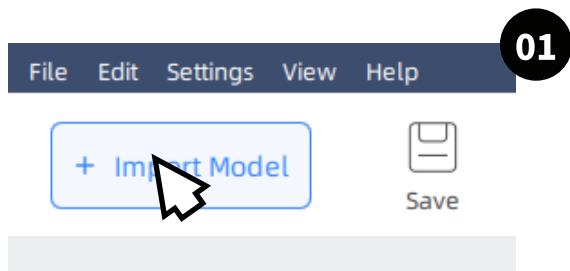

Select a file

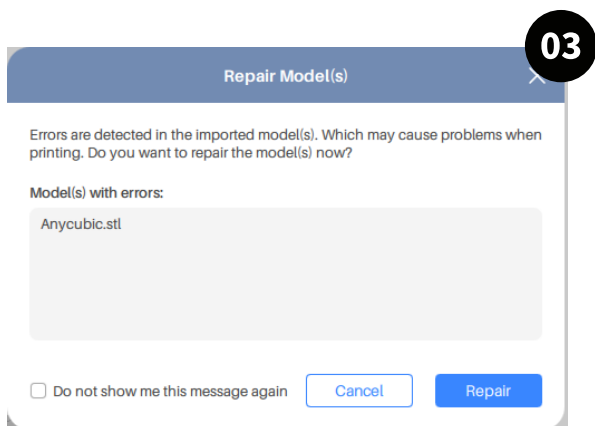

Repair the model*

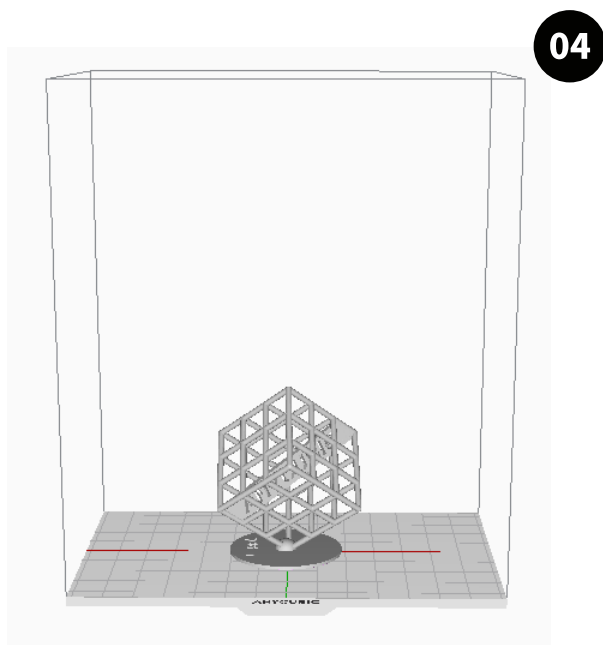

The object is imported

*If the automatic check of the models quality is unnecessary, cancel the selection of "Automatically check the quality of imported models" in Settings-Configuration-Model Repair.

Settings

When the models are selected to edit, they are highlighted.

If you want to check or edit one of several models, click  of other models in the objects list to hide them. When a model is hidden, the functions such as move, rotate, hollow, pinch are unavailable to it. Also, it cannot be added supports or be sliced.

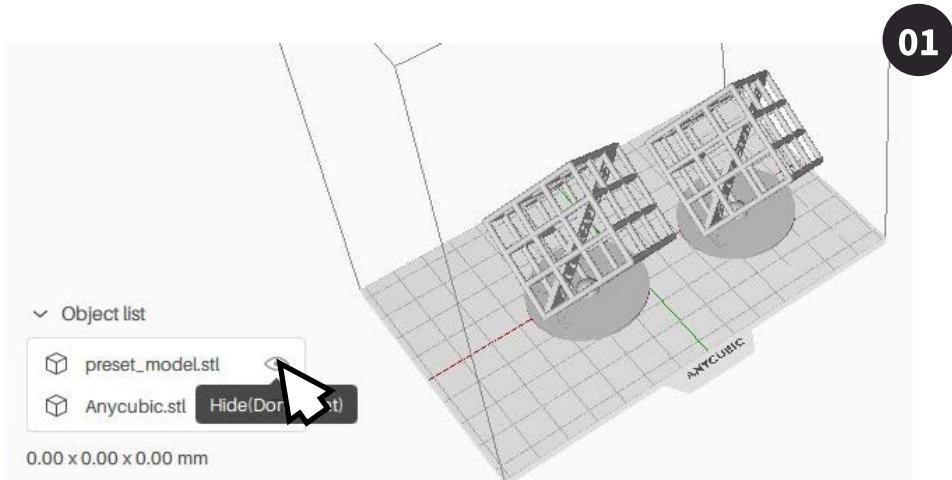

Click to hide the model

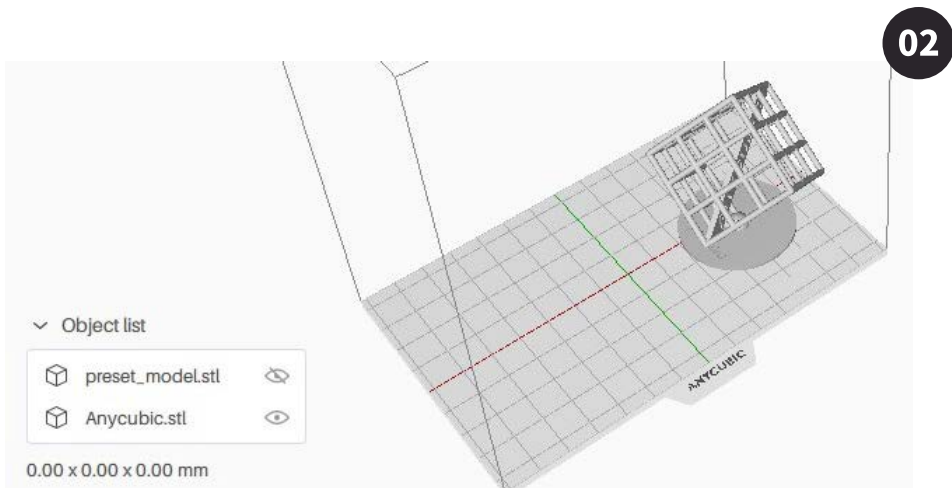

Settings

2. Machine Configuration Manage

① Machine settings

Click  or Machine-Manage Printer and add the type of your printer in the interface. Different printer types have different parameters, please choose the printer you use to avoid print failure.

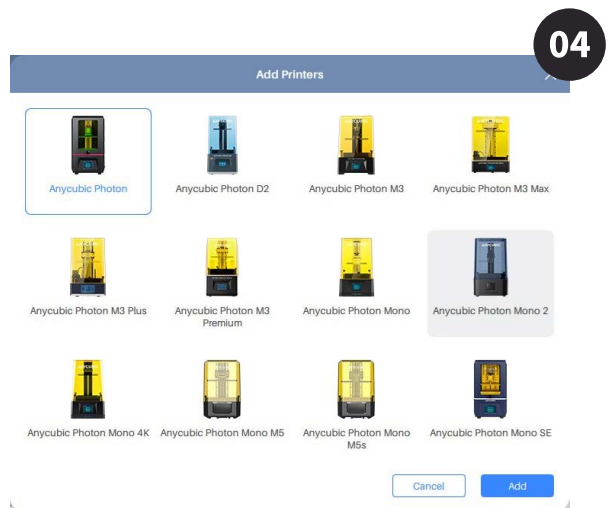
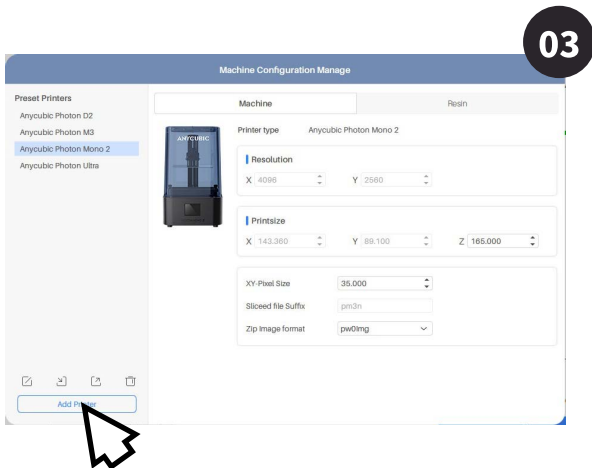
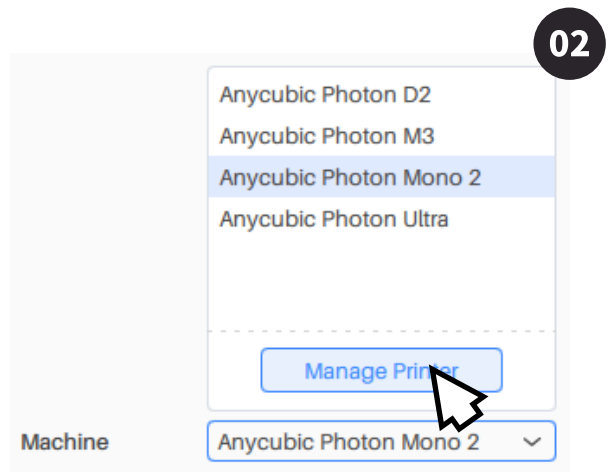
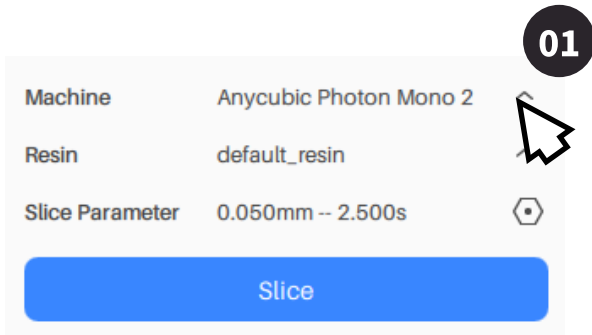

Select your 3D printer

Settings

② Resin Settings

Add and edit resin types to configure different sets of print parameters for different resin or models requirements, as shown in the following:

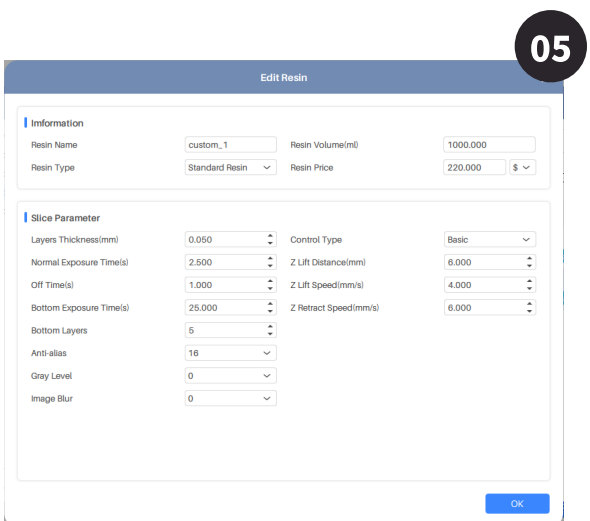
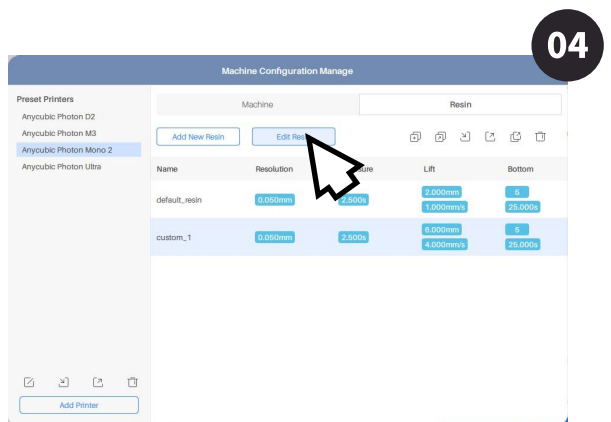
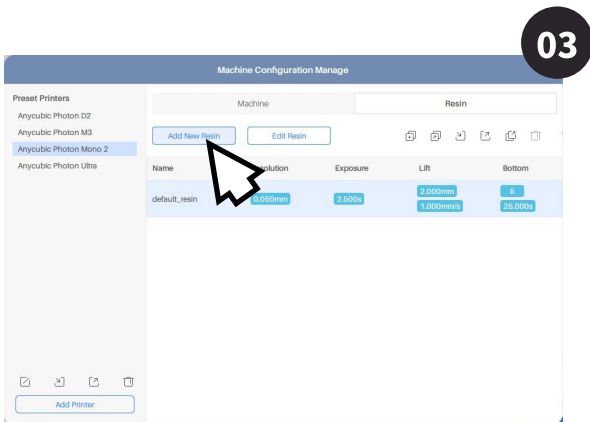
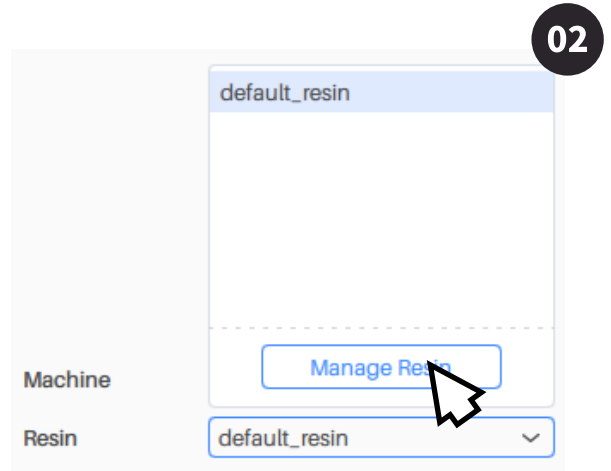
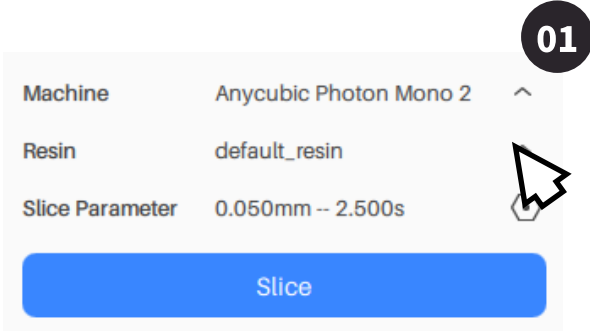

Set resin and slice parameter
Then click OK to finish

Settings

Set slice parameters according to your requirement in Edit Resin interface. Then, click “OK” to apply it. [The recommended parameters is shown in User Manual-Recommended Printing Parameters.](#)

Slice parameter instruction

- **Layer Thickness:** The thinner the layer, the better the accuracy of Z-axis direction. The thicker the layer, the longer the exposure time for each layer.
- **Normal Exposure Time:** The length of normal exposure time depends on UV power, complexity of model, resin materials and so on. Underexposure may cause uncured detail, overexposure may affect accuracy of model.
- **Off Time:** The UV light will be off for a certain time between each layer. The longer off time allows resin with poor fluidity to reflow.
- **Bottom Exposure Time:** The longer the bottom exposure time is, the easier the bottom layers of the model stick to platform.
- **Bottom Layers:** The bottom layers need to be exposed for longer time to stick model to platform tightly. The bottom layers may be larger than normal layers.
- **Z Lift Distance:** The model requires enough distance to be separated from the FEP film.
- **Z Lift Speed:** If the lift speed is too fast, the model will be broken and supports may also be damaged due to the separation force.
- **Z Retract Speed:** If the retract speed is too fast, the printing quality may be damaged.

Settings

- **Anti-alias:** A higher grade of anti-alias value could enhance the ability to smooth the edges for each layer during printing, thereby resulting better surface of the printed objects. A higher grade of anti-alias value also means longer slicing time and larger files.
- **Surface Abrazine (for some types of printer):** Only when anti-alias value is 1 can you check this option to get a matte surface.

When anti-alias value is larger than 1, you can set the grades of gray level and image blur according to the requirement.

- **Gray Level:** The higher the gray level, the brighter the pixels of anti-alias.

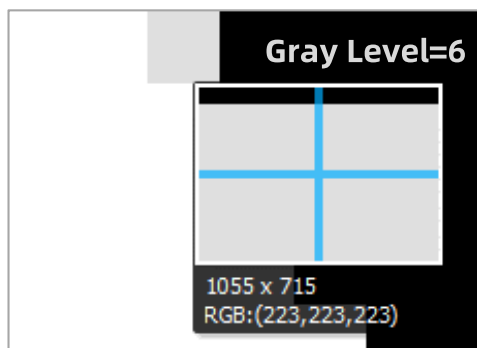
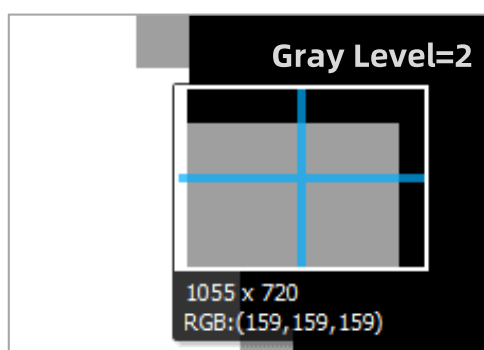

- **Image Blur:** It blurs the edge of image to achieve the natural cohesion. The higher the grade of image blur, the more blurry it is.

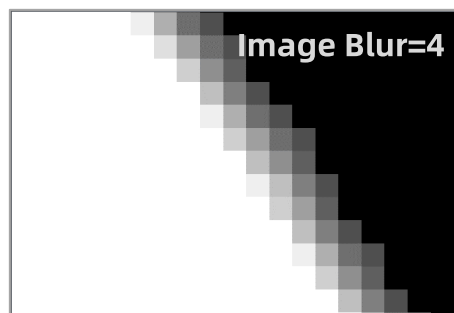
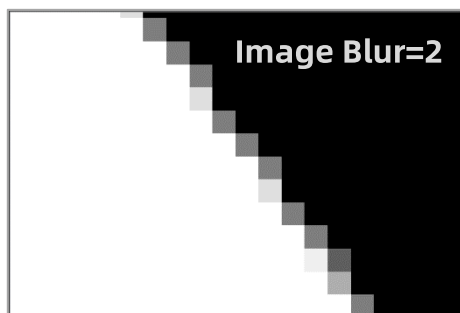

In the process of printing, please comprehensively consider the grade of anti-alias, gray level and image blur according to the actual requirement to get the best surface quality.

Settings

Advance

In basic mode, Z lift time, Z lift speed and retract speed of the bottom layers are the same with those of normal layers. However, if you want to reduce the printing time or achieve better print effect, switch to advance mode to set different parameters of Z-axis moving in different stages and layers.

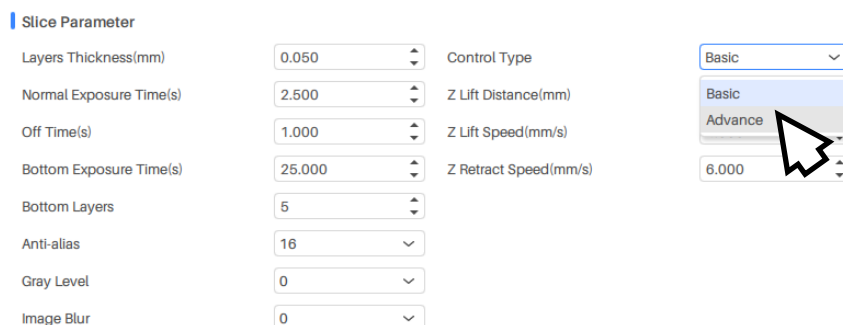

Switch to advance mode

- **Bottom layers control:** To set Z lift height, Z lift speed and Z retract speed of the bottom layers.
- **Normal layer control:** To set Z lift height, Z lift speed and Z retract speed of the normal layers.
- **Transition layer count:** The transition layers between the bottom layers and normal layers. The more the transition layers are, the longer the time transition costs.
- **Step [0]:** The stage when printing platform is moving near the curing face. The speed of this stage is relatively slow to avoid affecting the printing.
- **Step [1]:** The stage that printing platform is moving away from the curing face. The speed of this stage is relatively fast to shorten the printing time.

Settings

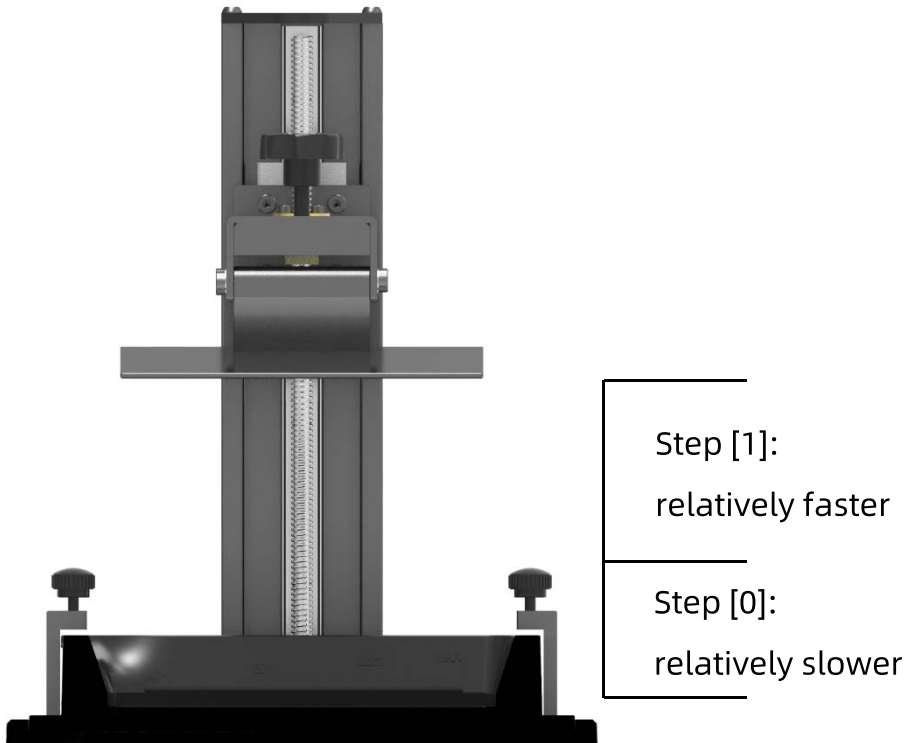

*Each Z lift height in Step[0] and Step[1] corresponds to distance of two printing platform's motion.

Settings

3. Anycubic Cloud (for Anycubic Photon M3 Plus, Photon M3 Premium, Photon Mono M5, Photon Mono M5s, Photon Mono M7, Photon Mono M7 Pro)

If your printer is supported to use the Anycubic Cloud, you can save the sliced file to Anycubic App or remotely start the print job after slicing.

① Log in Anycubic Cloud.



Click to enter in log in interface

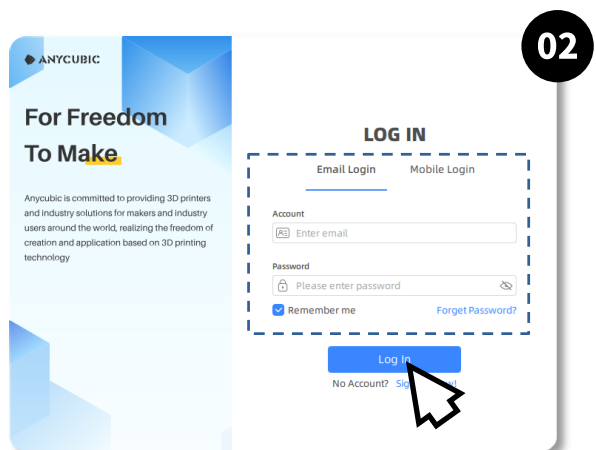

Enter your account and password then click log in

② Add printer.

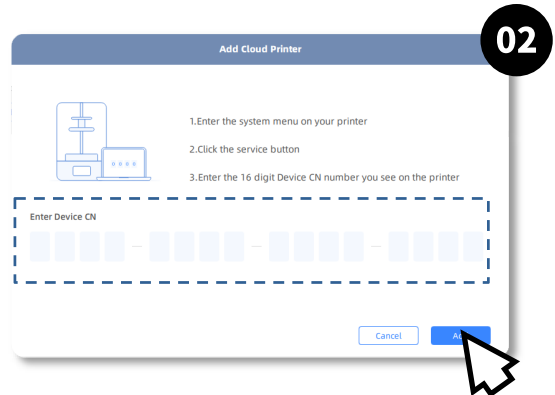
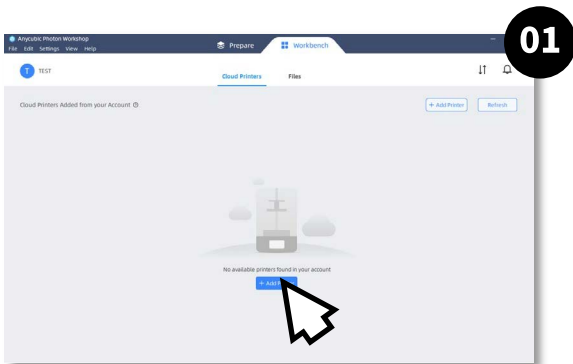

Enter the **device CN*** to add printer

***You can check the device CN on the touch screen of the printer. For details, please refer to the user manual of the corresponding printer type.**

Introduction to Functions

1. View Changing

① View angle

- **Mouse:** Scroll the mouse wheel to zoom in/out; left click the platform and drag to move it; right click the platform and move to change view angle.
- **Interface controls:** click the surfaces of cube to change view angle; right click the cube and move to change view angle; click  to switch to isometric view.
- **View menu:** Switch to different views.

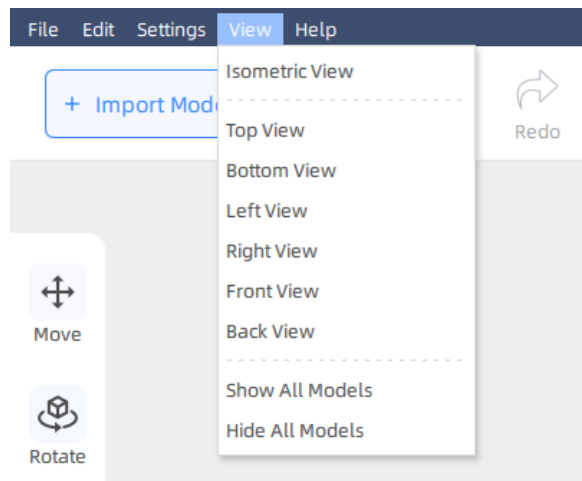

② View mode

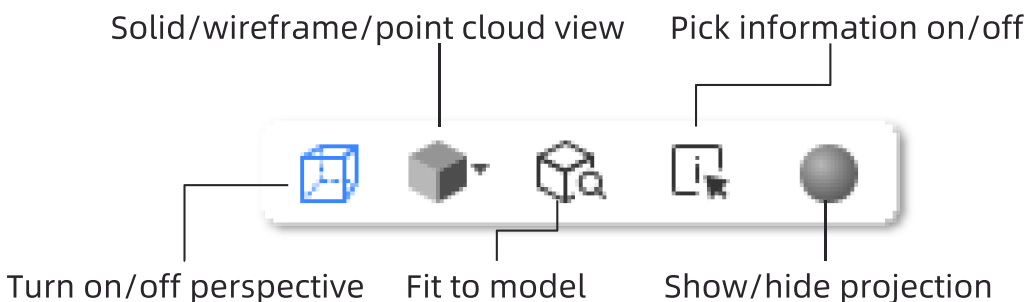

Introduction to Functions

2. Model Edit

Move: Input a number or manipulate the controls to move the model.

Rotate: Input a number or manipulate the controls to rotate the model. Click "Rotate by Face" to select a face to align model to the build plate.

Scale: Input a number or manipulate the controls to scale the model. Click "Scale to Fit" to scale the model to its maximum size for the printer.

Mirror: Mirror the model in X, Y or Z direction.

Layout: Place the models according to the settings of model interval, order, position and so on. It increases the space utilization to print more models in one time.

- The Bigger the model spacing, the less the models can be placed.
- Rotate the models on Z-axis to increase the space utilization.
- Set the placing order according to the personal requirements.

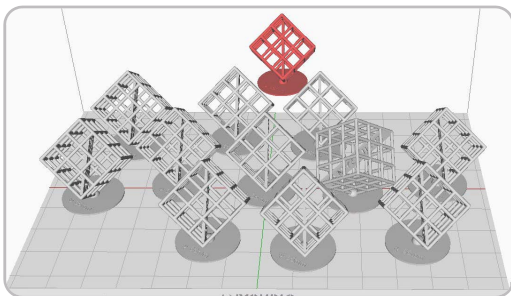

Model Spacing 2mm

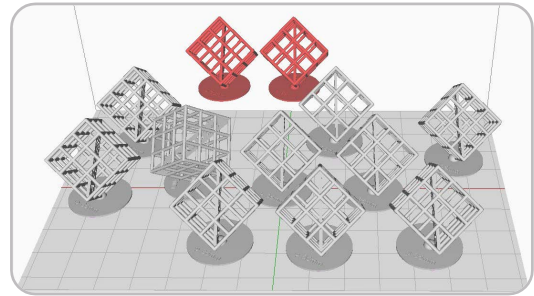

Model Spacing 3mm

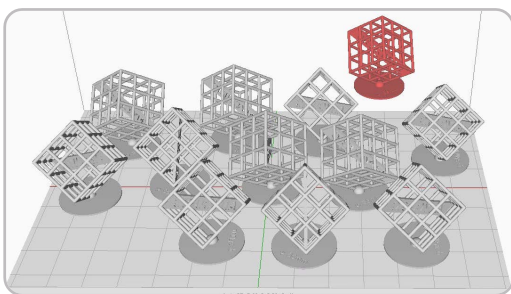

Rotate 45°

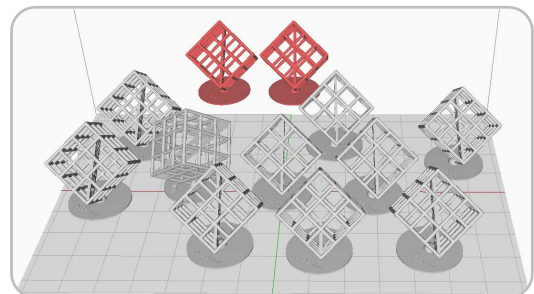

No Rotation

Notice: The red part out of the print range is not printable.

3. Clone

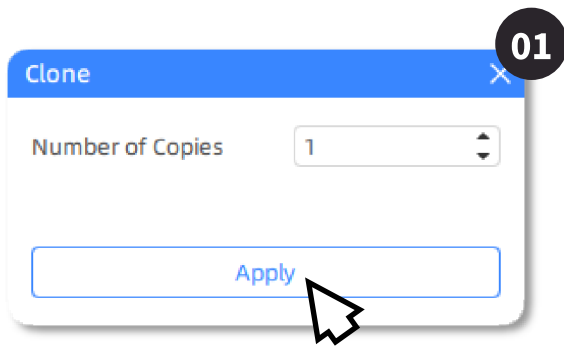

Set the number and apply

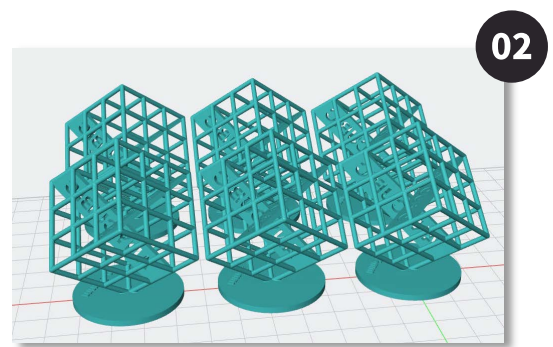

Introduction to Functions

4. Repair

Check if there are problems such as bad orientation, bad edge, hole, intersection and repair the models to increase the success rate of printing.

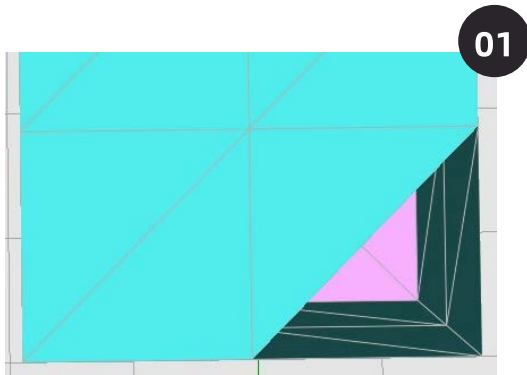

Model error

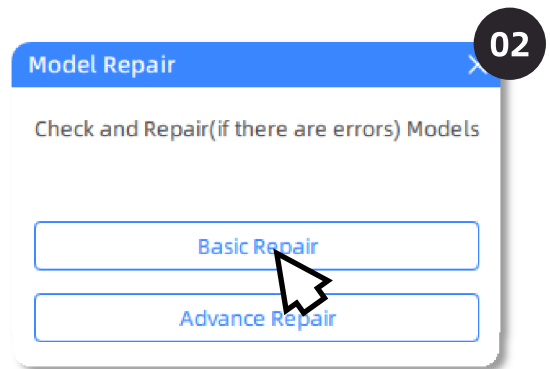

Click to repair

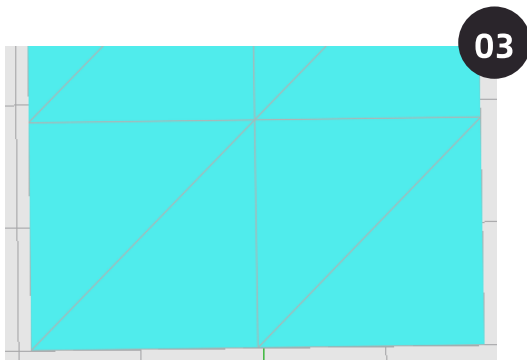

Basic Repair VS Advance Repair:

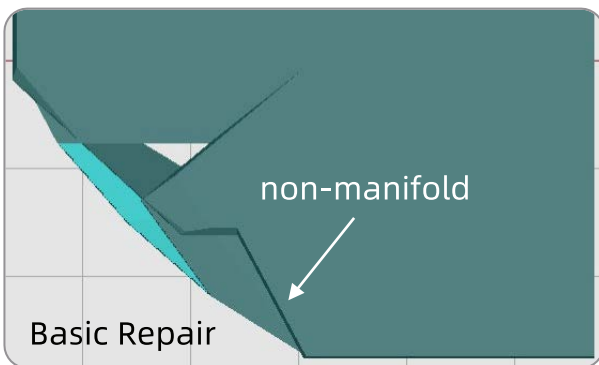

Mainly repair bad orientation and holes

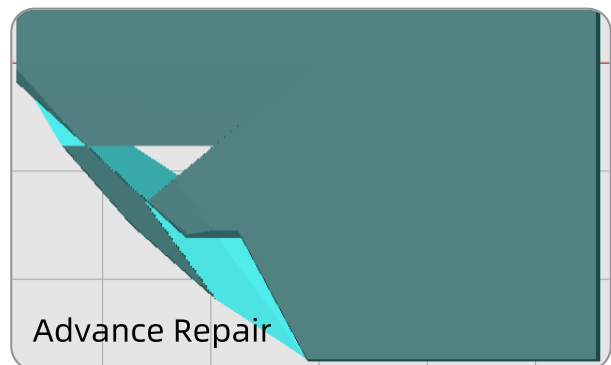

Repair of the intersection, non-manifold is added

5. Hollow

Hollow the model to reduce resin consumption.

BCC infill and FCC infill is more likely to help to drain the resin inside the models than other shape of infill.

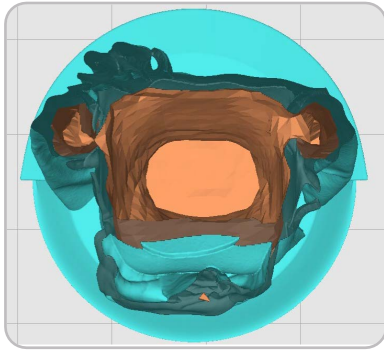

Hollow thickness: 1mm

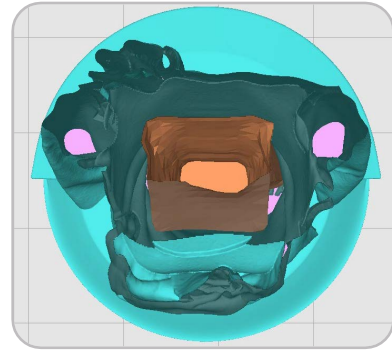

Hollow thickness: 3mm

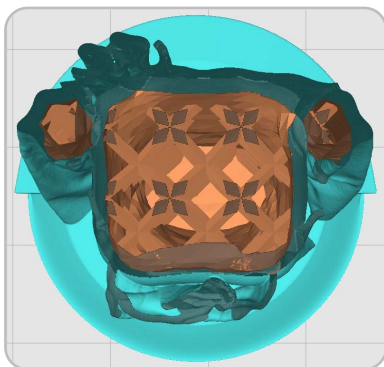

BCC infill

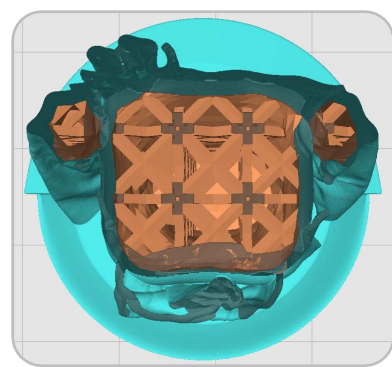

FCC infill

The model name: MIA

The author of the model: Fabio Nishikata

Introduction to Functions

6. Punch

If the model is hollowed, it is suggested to pinch at the side or bottom of the model to avoid the print failure caused by vacuum seal drawing. When the print is finished, that discharge the resin inside the model can prevent model being broken after a period of time.

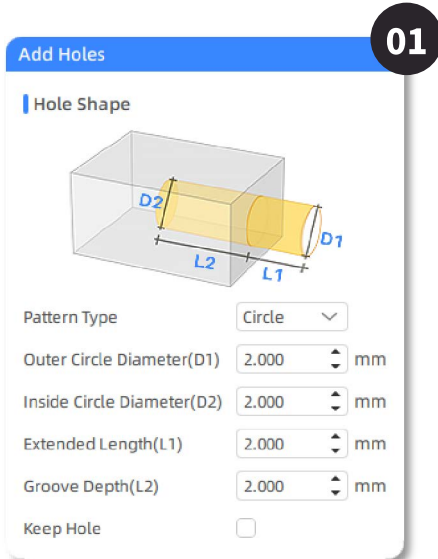

Set the parameters, L2 must be larger than hollow thickness

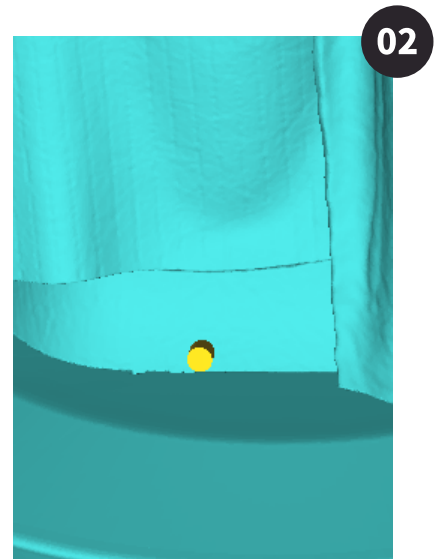

click on the model to pinch

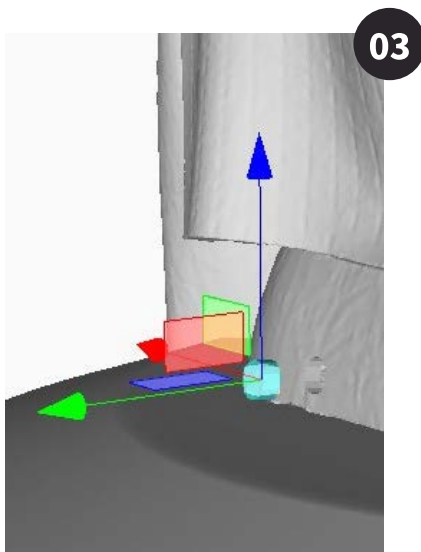

The cylinders needs to be place properly to be printed

The author of the model: Fabio Nishikata

Introduction to Functions

7. Free Cut

Adjust the cut facet by the following three methods and then click “Perform Cut” to generate groups.

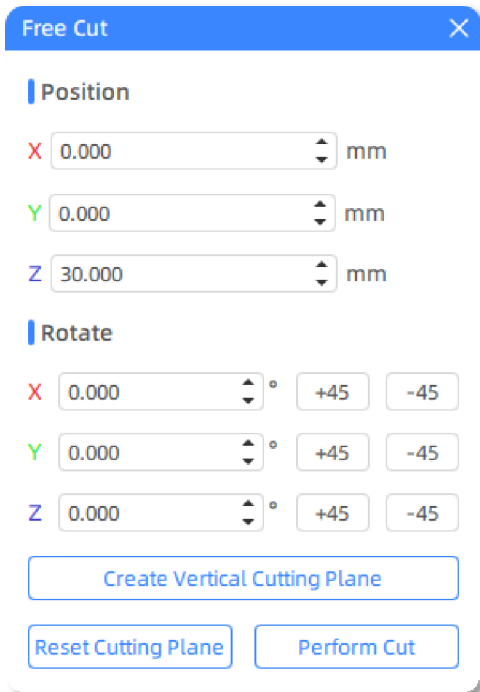

Adjust the cut facet by modify the parameters

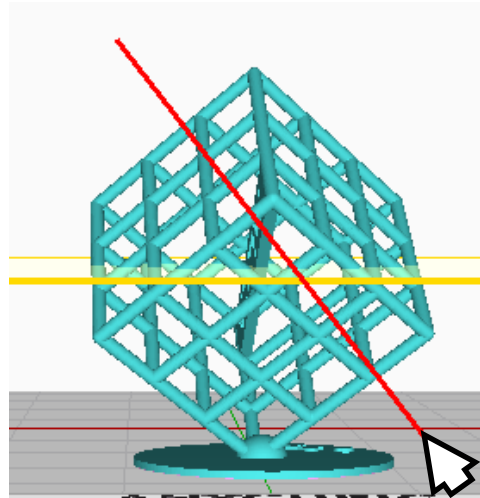

drag cross the model to draw the cut face

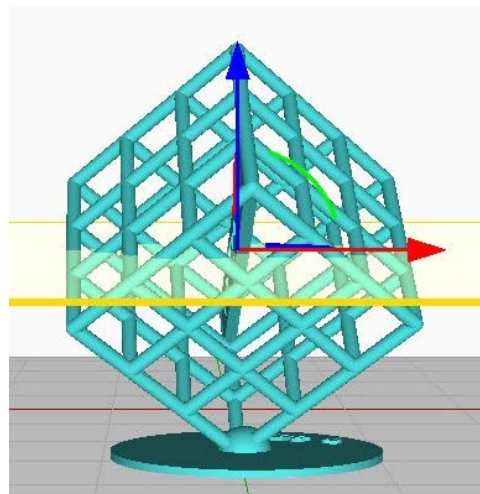

Adjust the cut facet by control

8. Text

- Add mode

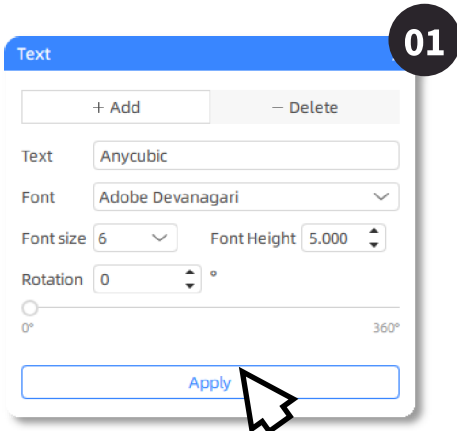

Set the text and then click "Apply"



Click on the place to add text

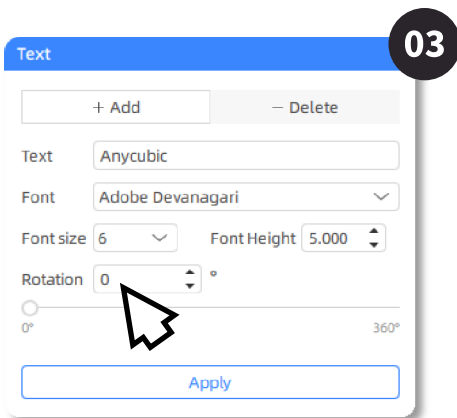

Adjust the angle of the text

Introduction to Functions

- Delete mode

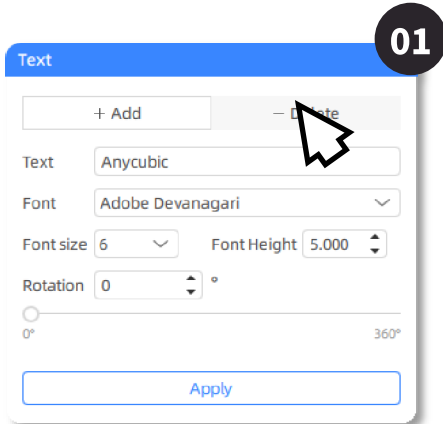

Switch to delete mode



Click to select the text

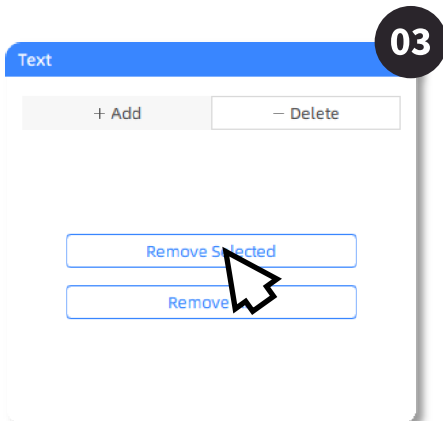

Remove selected text
or remove all text

The author of the model: Fabio Nishikata

Introduction to Functions

9. Face Model

It is the function reconstructing a face from 2D pictures into a 3D form.

① Upload the proper photos according to the requirements below:

- **Environment:** The light should be even and balanced to avoid shadows on the face. The facial contour should be clearly visible.
- **Background:** The background of the photo should be single color. The dark background is better. (black>blue>red>white)
- **Dimensions:** Minimum acceptable dimensions are 84 pixels (width) ×112 pixels (height)
- **Facial Requirements:** Please present the front and side views with the entire head and face clearly visible. The facial expression should look natural with eyes open and mouth closed. Do not let eyeglasses, hat or other object obscure the facial features.
- **Note:** The side views should show the point between the eyebrows.

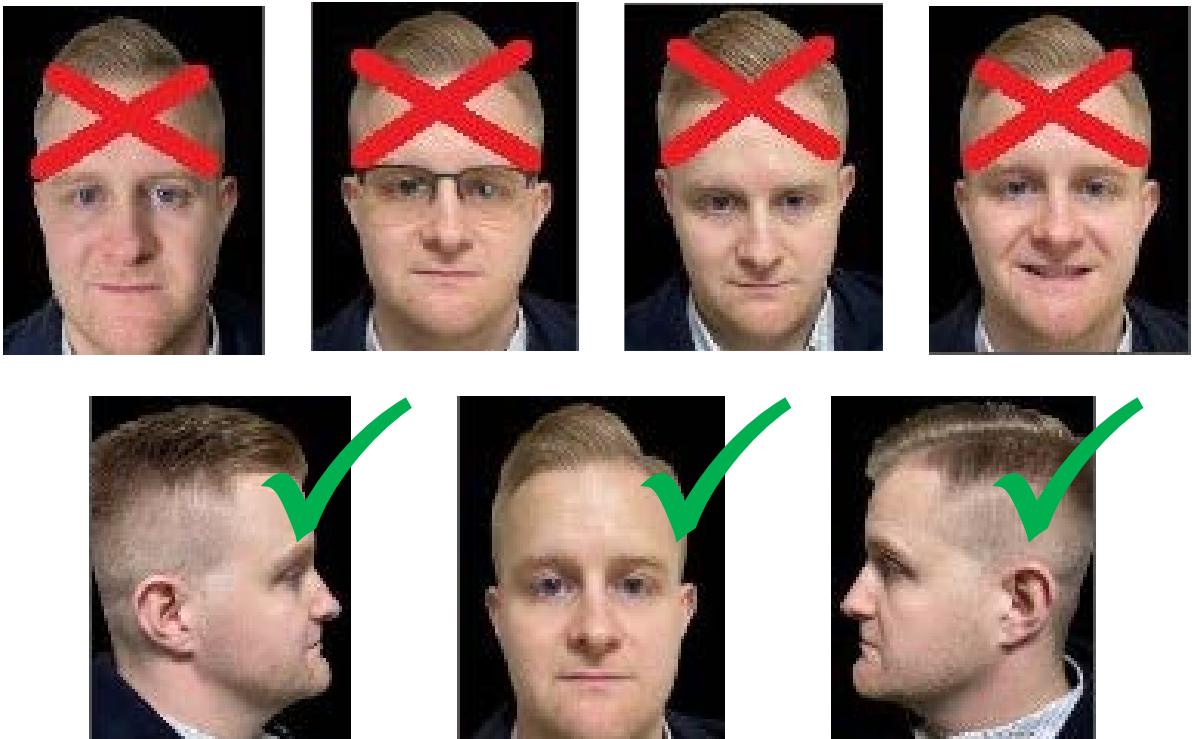

Introduction to Functions

② Click the corresponding points in accordance with the illustration and prompt to finish localization.



finished position is grey; current position is green
If you make a mistake, click the green cross to cancel.

③ When the steps are finished, click "Generate" to generate the face model.

Support Settings

When the model has obvious suspended parts or overhang, it needs to add support to reduce the risk of printing failure.

There are three support scripts: light, medium and heavy.

Light: Contact area between the support and model is small, and the support is easy to remove.

Heavy: Support contact with the model area is large and solid.

It is recommended to try the “Medium” first, and use the default settings. Also, you can add the support scripts and modify the parameters to fit your requirement.

1. Basic Settings

Support Angle: The larger the support angle, the more the supports.

Anchor Distance: The distance between supports. The shorter the distance, the more the supports.

Z Lift Height: Raise the models before adding supports to avoid bottom of the models being destroyed during printing.

- **Automatic Supports**



Support Settings

Automatic



add between platform and model,
between points on model

on platform



add between platform and model only

• Manual Supports

Add: Click the point on model which is needed support to add support.

The image shows three numbered steps for manual support placement:

- 01:** A screenshot of the 'Support' settings panel. The 'Support script' is set to 'Medium'. The 'Support Angle' is set to 50.000 degrees. The 'Anchor Distance' is set to 2.300 mm. The 'Z Lift Height' is set to 5.000 mm. There are buttons for 'Manual Editing' and 'Remove All Supports'.
- 02:** A 3D model of the woman in the blue dress. A mouse cursor is clicking on a point on the model's face to add a support.
- 03:** A screenshot of the 'Manual Editing' panel. It shows the 'Anchor Show Size' slider set to 'Small'. The 'Support Angle' is set to 50.000 degrees. There are buttons for 'Remove Selected Anchors', 'Discard', and 'Apply'.

Edit: Select a anchor and then drag to move it.

Delete: Select an anchor and remove it; or remove all supports directly.

Support Settings

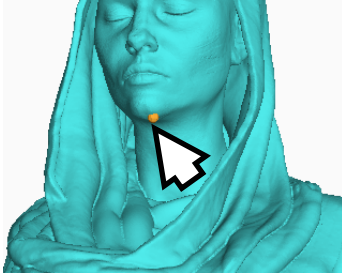

Click to select the anchor



Shift+drag to select the supports in an area;
ctrl+click to select several supports;
alt+drag to deselect the supports in an area

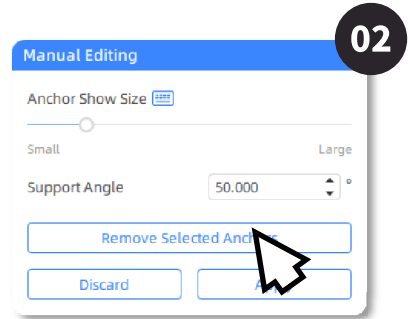

Remove the selected supports

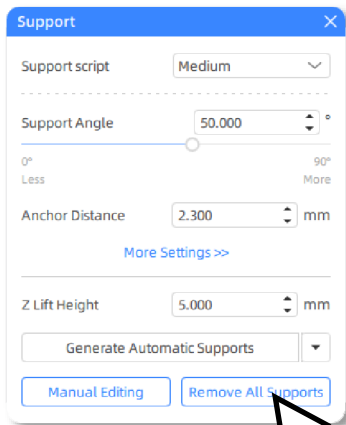

Remove all supports directly

The author of the model: Fabio Nishikata

Support Settings

2. Support Scripts Settings

If there are more detailed requirements for supports, you can configure different groups of support settings to fit.

① Configuration

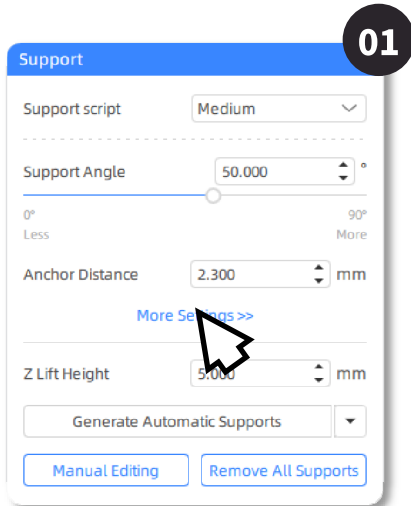

Enter in more settings

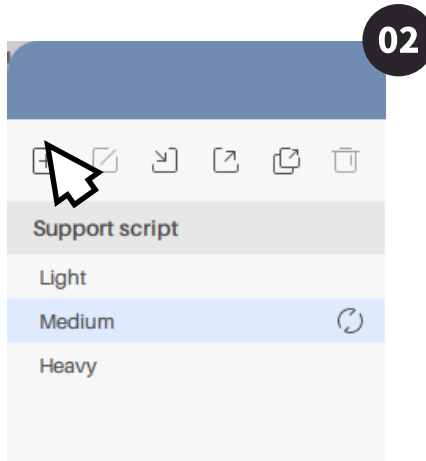

Add a script

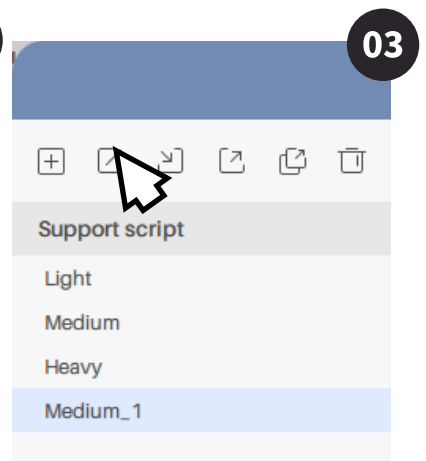

Rename

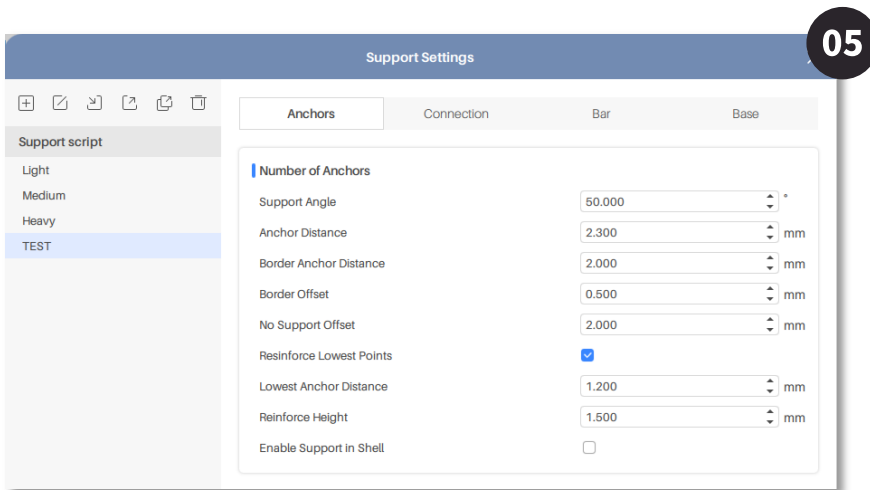

Set the support parameters

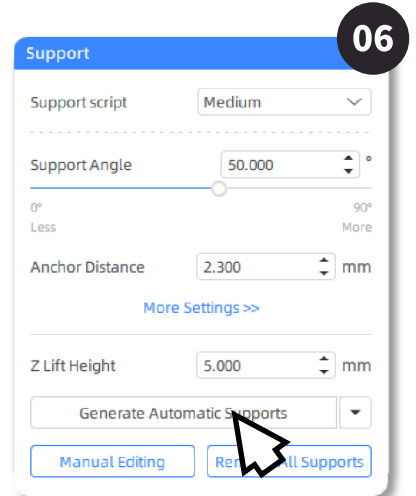

Back to support interface
Click to generate supports

Support Settings

② Support parameter instructions

- **Anchor**

Support Angle: The angle between the support surface and the horizontal plane. The larger the critical angle, the greater the area that needs to be supported.

Anchor Distance: The distance between the anchor points which are added out of border of the model. The shorter the distance, the more the supports.

Border Anchor Distance: The distance between the anchor points which are added on the border of the model.

Border Offset: The minimum distance between anchor points and the edge of the model.

No Support Offset: The minimum distance between the anchor points on the overhang. The shorter the distance, the more the anchor points.

Reinforce Lowest Points: To increase the anchor points at the lowest part of the models.

Lowest Anchor Distance: The distance between the anchor points at the lowest part of the models.

Reinforce Height: The height of the lowest part which is reinforced.

Enable Support in Shell: Add support to the hollowed part.

- **Connection**

Distance in Model: The length of the support bar inserting into the lower surface of the model. An appropriate connection length can ensure that the support top is rough enough and easier to remove.

Top Width: The width of the contact point that touches the lower surface of the model. The larger the width, the larger the contact area between the support and the model.

Support Settings

Ball Contact: To set the contact shape as ball.

Ball Diameter: The larger the diameter, the larger the contact area.

Length: The distance between the lower surface of the model and the contact point widened to middle width.

Tip Type: Set the tip being perpendicular to contact area/horizontal plane.

Break Point: Set break points where tips contact the models to make the treatment easier .

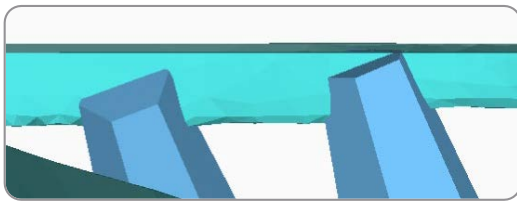

No break point

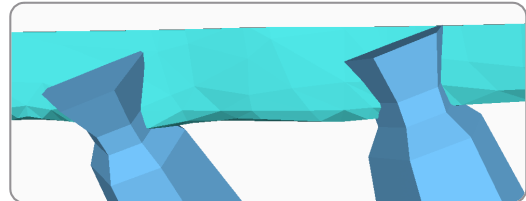

Break point

Break Point Height: Length of the break point.

Break Point Width: Width of the break point.

Start Height: The distance from the top of the model to the break point.

End Height: The distance from the break point to the tip inside the models.

Filter Supports

Remove Short Supports: When it is enabled, the supports shorter than a set length cannot be generated on the model.

Change the Width of Support: When it is enabled, the width of the supports on the model which are shorter than a set length are changed according to the set width scale.

Platform Connection

Height: The height of the support platform.

Radius: The larger the radius, the larger the support platform.

Slope Angle: The slope angle of the edge of the support platform.

Support Settings

- **Bar**

Polygon Edge Number: The number of the sides for the Polygonal prism.

Max Branch Number: The maximum number of the branches of the bar.

Branch Top Width: The width of where branch contacts the model.

Branch Bottom Width: The width of where branch contacts the trunk.

Trunk Top Width: The width of where trunk contacts all branches.

Trunk Bottom Width: The width of where trunk contacts platform or base.

Trunk Height

Automatic: Automatically generate supports by the suitable parameters.

Max Height: Set the maximum trunk height to generate supports.

Branch Max Angle: Set the maximum branch angle to generate supports.

Bar Cross Connection

Cross Type

MST Method: To ensure the anchor points all being linked and the cross is less.

Min2 Method: To ensure the anchor points all being connected and the cross may be more.

Border Method: Only connect the anchors on the edge of the models.

Connection Type

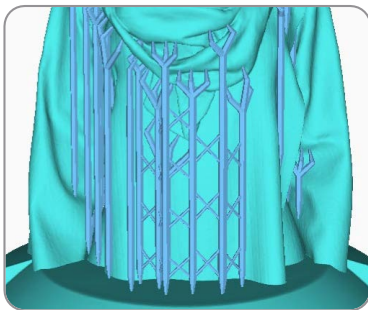

Cross Connection

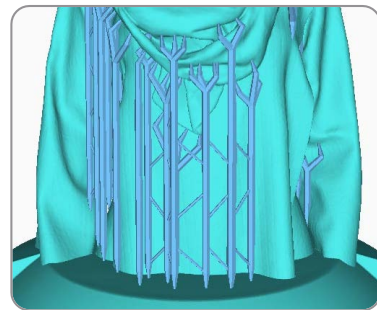

Alternate Connection

Start Height: Cross is generated from a certain height.

Cross Bar Width: The width of the cross.

Cross Bar Angle: The angle between the cross and horizontal plane.

Interval Height: The distance between the cross.

Support Settings

- **Base**

Add base to increase the adhesion between model and the print platform to reduce the risk of the print failure.

Plate Offset: The minimum distance between the support and edge of the base. The larger the offset, the larger the base.

Plate Height: The thickness of the base.

Slot Angle: The slope angle of the edge of base.

Plate Type:

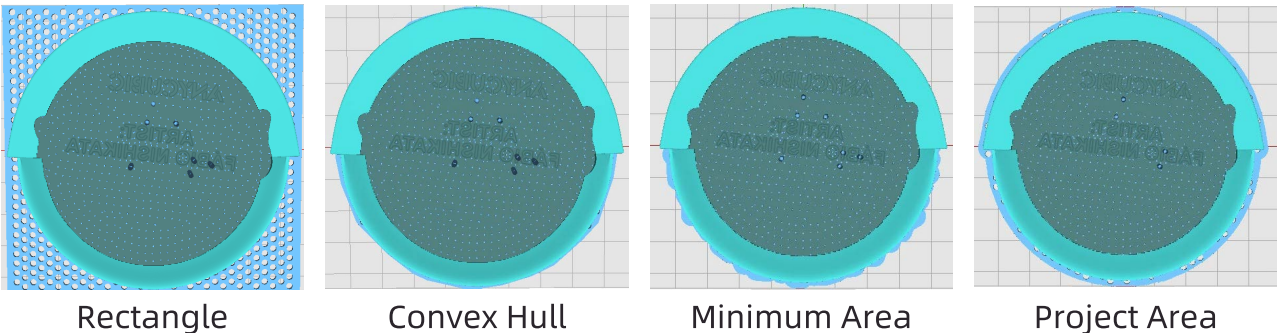

Perforation: Enable perforation to save resin.

Hole Radius: The larger the holes, the less the resin needed, the smaller the contact area with the print platform.

Hole Interval: The larger the interval, the less the holes.

Hole edge number: The larger the edge number, the more similar to circle the hole is.

3. Automatic Support Adding Skills

- **Properly increase support angle or decrease anchor distance**

When browsing on the model, it can be found that the model still has some weak points that have not been added supports properly. If you increase support angle or decrease anchor distance, more supports can be added to some of the weak points.

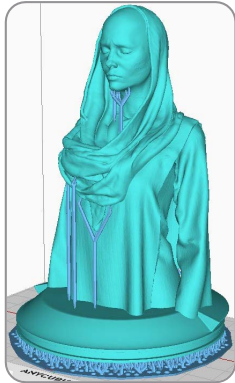

Support angle 30°

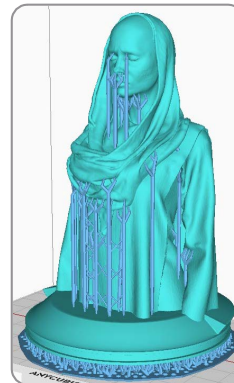

Support angle 50°

- **Add manual support after automatic support**

Manually add support to some of the weak points.

- **Check Land**

Click "Check Islands" in slice file preview interface, then drag slider to check the image of every layer. The green part means there is support below; the yellow part is connected to other parts but may be suspended and may need supports; the red part is completely suspended and must be added supports.

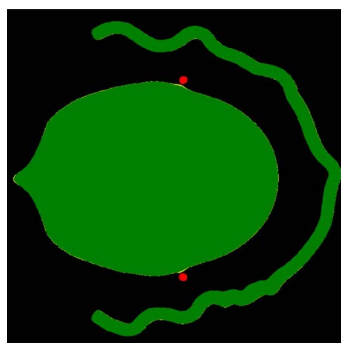

The author of the model: Fabio Nishikata

Support Settings

4. Save Scene File (Optional)

Save the current scene including model, settings, supports and so on for easy reuse and editing.

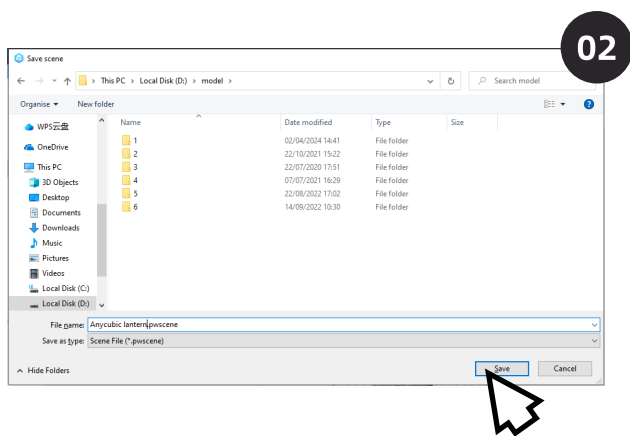
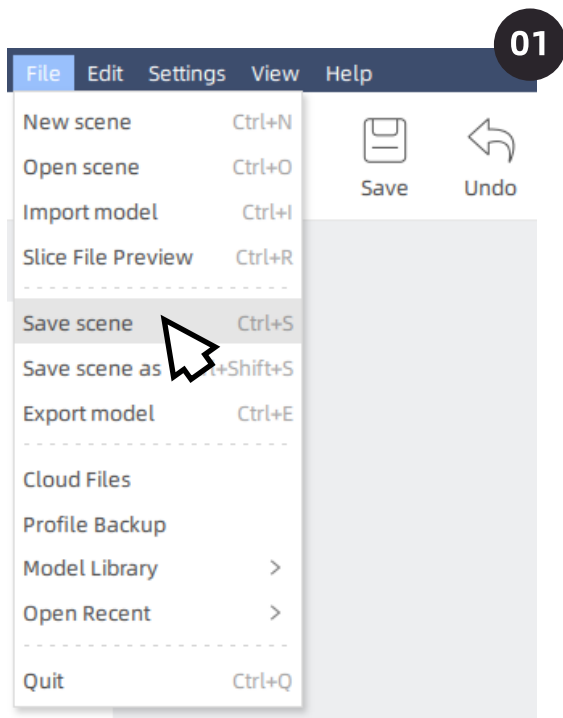

Export Sliced File

1. Slice

When the setting is finished, click Slice. Anycubic 3D printer can only read its corresponding sliced file formats, please choose the machine type you use at Machine Settings to avoid print failure.

It is suggested to add supports if it prompts that the model with some overhanging areas is needed supports. To cancel the automatic check for supports, enter into settings-preferences-slicing and uncheck "show support model prompt dialog when slicing".

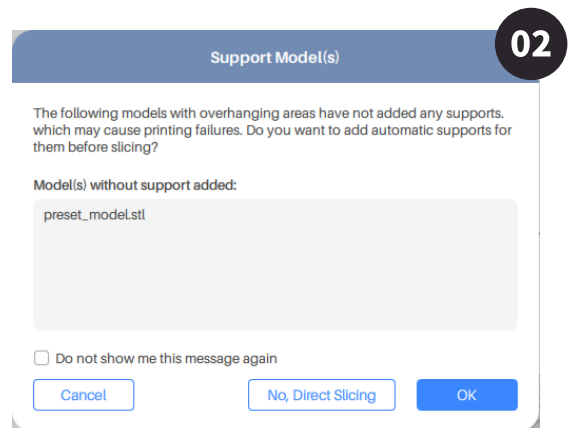
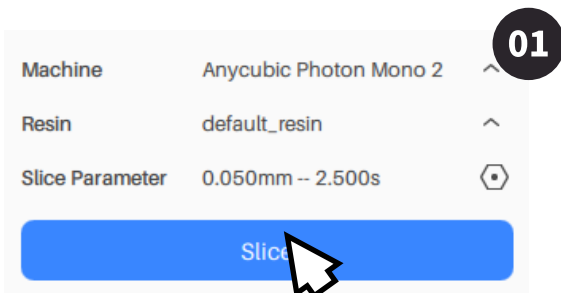

Check the supports

2. Preview

In the slice file view interface, you can preview slice settings and adjust the slice settings.

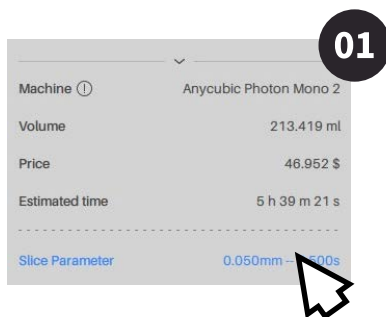

Click to enter in the slice setting interface

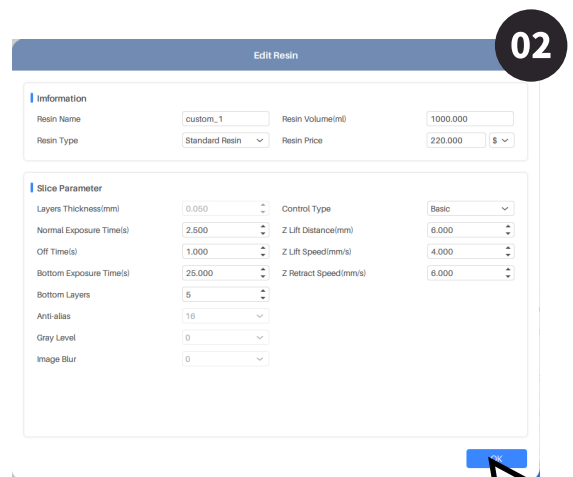

Adjust the parameters then click OK to save

Export Sliced File

3. Export

- **Return:** If some other manipulations of model are needed, click “Return” and go back to editing interface.
- **Remote Print:** Send the sliced file to the printer and start printing. The print job can be remotely controlled by Anycubic App.
- **Save Sliced File**

Save to Disk: Save the sliced file to PC.

Save to Cloud: Save the sliced file to Anycubic App.

